

The ibidi product family is comprised of a variety of μ-Slides and μ-Dishes, which have all been designed for high-end microscopic analysis of fixed or living cells. The high optical quality of the material is similar to that of glass, so you can perform all kinds of fluorescence experiments with uncompromised resolution and choice of wavelength.

The μ-Slide 4 well Ph+ (Phase contrast plus) is an array of 4 square fields where cells can be cultivated and investigated with microscopical methods. The μ-Slide 4 well Ph+ improves the optical quality of phase contrast microscopy. In contrast to the classic μ-Slide 4 well, the Ph+ version provides a special plate in the center of the wells. This plate suppresses

the meniscus which is disturbing the phase contrast effect in normal open wells. Openings near the corners provide access to the wells for filling and aspirating liquids easily.

## Material

ibidi μ-Slides, μ-Dishes, and μ-Plates are made of a plastic that has the highest optical quality. The polymer coverslip on the bottom exhibits extremely low birefringence and autofluorescence, similar to that of glass. Also, it is not possible to detach the bottom from the upper part. The μ-Slides, μ-Dishes, and μ-Plates are not autoclavable, since they are only temperature-stable up to 80°C/175°F. Please note that gas exchange between the medium and incubator's atmosphere occurs partially through the polymer coverslip, which should not be covered.

### Optical Properties ibidi Polymer Coverslip

Refractive index $n_D$ (589 nm)	1.52
Abbe number	56
Thickness	No. 1.5 (180 μm)
Material	polymer coverslip

**Please note! The ibidi Polymer Coverslip is compatible with certain types of immersion oil only. A list of suitable oils can be found on page 3.**

## Geometry

The μ-Slide 4 Well Ph+ provides a standard slide format according to ISO 8037/1.

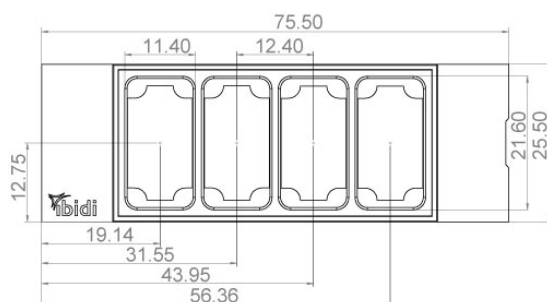

### Geometry of μ-Slide 4 Well Ph+

Outer dimensions in mm (w × l)	25.5×75.5
Number of wells	4
Dimensions of wells in mm (w × l × h)	21.6 × 11.4 × 3.0
Volume per well	700 μl
Liquid height	3.0 mm
Total height with lid	10.8 mm
Growth area per well	2.5 cm <sup>2</sup>
Coating area per well	5.9 cm <sup>2</sup>
Bottom	ibidi Polymer Coverslip

## Shipping and Storage

The μ-Slides, μ-Dishes and μ-Plates are sterilized and welded in a gas-permeable packaging. The shelf life under proper storage conditions (in a dry place, no direct sunlight) is listed in the following table.

### Conditions

Shipping conditions	Ambient
Storage conditions	RT (15-25°C)

### Shelf Life of Different Surfaces

ibiTreat, Glass Bottom, ESS	36 months
Collagen, Poly-L-Lysine	18 months

## Surface

The tissue culture treated ibiTreat surface is a physical surface modification and optimized for adhesion of most cell types. The uncoated surface is a very hydrophobic surface and allows no direct cell growth. It is suitable for specific coatings or suspension cells.

If you like to establish a particular coating for your demands we recommend testing your coating procedure on uncoated and ibiTreat surfaces, since some proteins and biomolecules adhere differently to hydrophobic or hydrophilic polymer surfaces.

## Coating

Specific coatings are possible following this protocol:

1. Prepare your coating solution according to the manufacturer's specifications or reference.
2. Apply 700 μl and leave at room temperature for at least 30 minutes.
3. Aspirate the solution and wash with the recommended protein dilution buffer.
4. Optionally let dry at room temperature. Attention, some coating proteins might degenerate when drying!

Detailed information about coatings is provided in [Application Note 08 Cell culture coating](#).

## Seeding Cells

- Trypsinize and count cells as usual. Dilute the cell suspension to the desired concentration. Depending on your cell type, application of a  $5-11 \times 10^4$  cells/ml suspension should result in a confluent layer within 2-3 days.
- Apply 700 μl cell suspension into each well of the slide. Avoid shaking as this will result in inhomogeneous distribution of the cells.
- Cover the slide with the supplied lid. Incubate at 37°C and 5% CO<sub>2</sub> as usual.

Undemanding cells can be left in their seeding medium for up to three days and grow to confluence there. However, best results might be achieved when the medium is changed every 1-2 days. Carefully aspirate the old medium and replace it by 700 μl fresh medium per well.

### Tip:

The day before seeding the cells we recommend placing the cell medium and the μ-Slide into the incubator for equilibration. This will prevent the liquid inside from emerging air bubbles over the incubation time.

## μ-Slide 4 Well Selection Guide

### μ-Slide 4 Well

Standard open wells for maximum sample access. Meniscus disturbs the beam path. Good phase contrast quality only in the center of each well

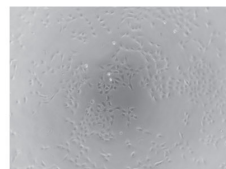
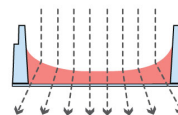
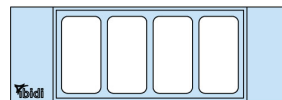
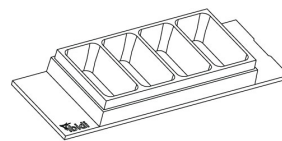

### μ-Slide 4 Well Ph+

Special plate in the center of the wells suppresses meniscus formation. No meniscus – parallel beam path. For excellent phase contrast microscopy all over the wells.

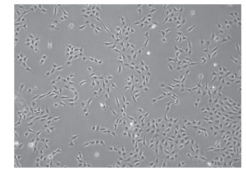
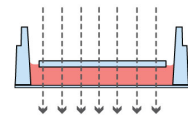
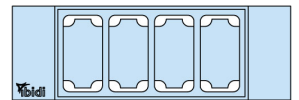
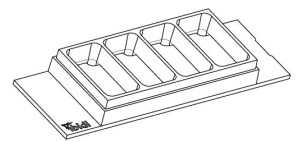

## Filling and Handling

Fill the wells by using a standard pipet. Inject the cell suspension directly into one of the openings. Medium exchange is easily done by aspirating the entire volume and refilling using 700 μl per well.

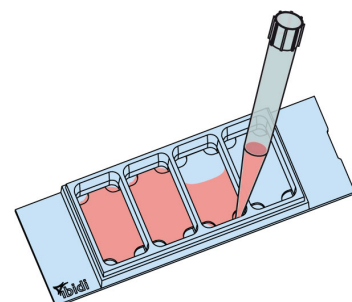

**Cell Microscopy and Solvents for Fixation**

To analyze your cells, no special preparations are necessary. Cells can be observed live, or fixed directly in the μ-Slide 4 Well<sup>Ph+</sup>, preferably on an inverted microscope. Due to the thin bottom, high resolution microscopy is possible. The material is compatible to most fixatives, like

acidic acid, alcohols and PFA. For a full list of compatible solvents and more information on chemical compatibility, please visit the FAQ section on [www.ibidi.com](http://www.ibidi.com). For optimal results in fluorescence microscopy and storage of stained probes ibidi provides a mounting medium (50001) optimized for μ-Dishes and μ-Slides.

**Immersion Oil**

When using oil immersion objectives with the ibidi Polymer Coverslip, use only the immersion oils specified in the table below. The use of any non-recommended oil could damage the ibidi Polymer Coverslip. The resulting leakage may harm objectives and microscope components. All immersion oils that are not listed in the table below should be considered as non-compatible.

Company	Product	Ordering No.	Lot Number	Test Date
ibidi	ibidi Immersion Oil	50101	16-12-27	01/2017
Zeiss	Immersionol 518 F	444960	160706	01/2017
Zeiss	Immersionol W 2010	444969	101122	04/2012
Leica	Immersion Liquid	11513859	n.a.	03/2011
Cargille	Type A	16482	100592	01/2017
Cargille	Type HF	16245	92192	01/2017
Olympus	Silicone Immersion Oil	SIL300CS-30CC	N4190800	01/2017
Carl Roth	Immersion oil	X899.1	414220338	01/2017

## Ordering Information

The μ-Slide 4 Well<sup>Ph+</sup> is available as open well and as a Ph+ version. See the table below for choosing your μ-Slide 4 Well<sup>Ph+</sup>.

### μ-Slide 4 Well

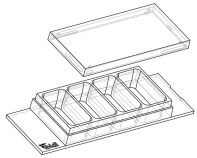

Cat. No.	Description
80426	μ-Slide 4 Well ibiTreat: #1.5 polymer coverslip, tissue culture treated, sterilized
80422	μ-Slide 4 Well Collagen IV: #1.5 polymer coverslip, sterilized
80424	μ-Slide 4 Well Poly-L-Lysine: #1.5 polymer coverslip, sterilized
80421	μ-Slide 4 Well Uncoated: #1.5 polymer coverslip, hydrophobic, sterilized
80427	μ-Slide 4 Well Glass Bottom: 1.5H (170 μm ±5 μm) D 263 M Schott glass, sterilized

### μ-Slide 4 Well<sup>Ph+</sup>



Cat. No.	Description
80446	μ-Slide 4 Well <sup>Ph+</sup> ibiTreat: #1.5 polymer coverslip, tissue culture treated, sterilized
80442	μ-Slide 4 Well <sup>Ph+</sup> Collagen IV: #1.5 polymer coverslip, sterilized
80444	μ-Slide 4 Well <sup>Ph+</sup> Poly-L-Lysine: #1.5 polymer coverslip, sterilized
80441	μ-Slide 4 Well <sup>Ph+</sup> Uncoated: #1.5 polymer coverslip, hydrophobic, sterilized
80447	μ-Slide 4 Well <sup>Ph+</sup> Glass Bottom: 1.5H (170 μm ±5 μm) D 263 M Schott glass, sterilized

## For research use only!

Further technical specifications can be found at [www.ibidi.com](http://www.ibidi.com). For questions and suggestions please contact us by e-mail [info@ibidi.de](mailto:info@ibidi.de) or by telephone +49 (0)89/520 4617 0. All products are developed and produced in Germany.

© ibidi GmbH, Am Klopferspitz 19, 82152 Martinsried, Germany.