

---

# Vertical autoclaves with prevacuums and drying

AE-B Series **CLASSIC LINE**

Technical information



# Why choose RAYPA?

Expert manufacturer, original design,  
global brand



## GLOBAL REACH

With half a century of experience, we have a long list of satisfied customers around the world. Currently, we export 85% of our annual turnover and have a stable network of distributors with presence in over 100 countries.



## EFFICIENT TECHNICAL SERVICE

Our team of highly qualified technicians and engineers is expert in our products. If you experience a technical issue, it will be our priority to rectify it. When you purchase a RAYPA unit, you're guaranteed top-level support and technical assistance.



## EXPERT MANUFACTURER

After more than 50 years in the industry, RAYPA is a global leader in the manufacture of laboratory autoclaves. Each of our autoclaves is designed and manufactured entirely within our modern facility equipped with the latest technology.



## FULL AND CUSTOMIZABLE RANGE

We offer an extensive portfolio of laboratory autoclaves to cover multiple applications and market segments. Discover the combination of autoclave model and accessories that best fits your needs within our 11 series and 35 available models.



## INNOVATION AND QUALITY

Our products feature advanced technology, ongoing innovation, superior construction quality, and are designed for a long service life. Our technical and engineering staff works tirelessly every day to optimize our products and exceed our customers' expectations.







## COMPREHENSIVE CONSULTANCY

Our team of specialists assesses each project and provides guidance to clients on the option that best suits their requirements. After the sale, we offer training on the use and recommended maintenance of each unit to ensure its optimal operation and extend its lifespan.

# Vertical autoclaves with prevacuums and drying

AE-B Series vertical floor-standing autoclaves with top-loading access cover all laboratory sterilization needs in many industries and research facilities with the aim of increasing the productivity of the laboratory. A great chamber capacity, the independent integrated steam generator, the touchscreen display, the independent clean water tank, the initial prevacuum pulses, the vacuum drying and the direct water discharge results in an excellent autoclave to perform from the most simple to the most demanding applications.

## RECOMMENDED APPLICATIONS

-  Porous solids and wrapped objects
-  Objects with complex geometries
-  Plastics and metal objects
-  Glassware
-  Laboratory waste bags
-  Culture media and liquids



Operation of the AE-75-B autoclave in conjunction with the MOB-LIFT mobile basket lift system.

# AE-B Series

## MAIN FEATURES

### EXCELLENT PERFORMANCE

AE-B Series autoclaves offer excellent performance for several sterilization procedures. They are equipped with an integrated steam generator, a vacuum pump and a heating jacket to guarantee proper steam penetration on all types of loads and completely dry solid loads.

### MULTIPLE TYPES OF STERILIZATION

A wide variety of options are available for sterilizing solids or liquids. Programmable parameters include automatic preheating, automatic start, number of initial prevacuum pulses, duration of vacuum drying, and the optional use of a flexible temperature probe for precise liquid sterilization.

### GREAT EASE OF USE

AE-B Series autoclaves are equipped with a 5" color touchscreen and include an independent clean water tank that automatically supplies the steam generator. For added convenience, an optional upgrade allows full automation of water supply directly from a water network. Discharge is always directly sent to the drain.

### SAFETY FIRST

AE-B Series autoclaves are designed with several features to ensure the safety of the operators. These include overpressure safety valve, overtemperature safety thermostats, water level detectors, an open door detection system and an independent safety pneumatic system that locks the main door while positive pressure is present in the sterilization chamber.

## ADVANTAGES



Immediate injection of steam thanks to the powerful integrated steam generator.



Adjustable number of initial prevacuum pulses to ensure optimal steam penetration into complex geometries, as well as porous or bulky objects, ensuring effective sterilization.



Equipped with heating jacket and vacuum pump, the system ensures complete drying of solid loads at the end of a sterilization cycle.



The sterilization chamber and door are made of high-quality AISI-316L stainless steel, providing exceptional resistance to corrosion.



Autoclaves manufactured in full compliance with all applicable European Union quality, regulatory and safety standards.



Control by a PID microprocessor and a 5" touchscreen. It includes 50 customizable programs adjustable by time, temperature, number of prevacuums, drying time and type of load (solids or liquids). Flexible probe control is optional.



Compatible with both the vacuum test and the Bowie-Dick test, featuring dedicated programs for each.



Suitable to sterilize all types of loads, including wrapped objects, porous objects, textiles, objects with complex geometries and bulky loads.



Automatic purified water supply to the integrated steam generator from the independent water tank, with water level sensors at both locations. Optional upgrade for automatic supply from a water network.



The discharge from each cycle is directly routed to the drain to minimize long-term corrosion and calcification of the sterilization chamber and water tank. An optional adaptation is available for using an external tank for discharge.



Automatic start-up and sterilization chamber preheating programmable by date and time.



User management with administrator hierarchy.



Optional software for sterilization data management.



Optional embedded printer.



Seamless mobility, all models include casters.

## WORKING PRINCIPLE

AE-B Series autoclaves meet the diverse sterilization needs of most laboratories, efficiently processing wrapped and unwrapped solids, fabric loads, porous and hollow items, plastics, metal instruments, laboratory waste bags, liquids, culture media, glassware, and other essential lab materials.

The load has to be placed in baskets inside the chamber, and after manually filling the independent clean water tank with purified water, the equipment starts to create the initial prevacuum, automatically supplies water to the integrated steam generator, producing saturated steam that is directly injected into the sterilization chamber until the set combination of sterilization time and sterilization temperature is reached.



## OPERATION OF A STERILIZATION CYCLE FOR SOLID LOADS

### PREHEATING PHASE

- In this initial step, the user has the option to set up a preheating temperature up to 70°C to speed up the duration of the sterilization cycle.

### PREVACUUM PHASE

- In this phase the equipment's vacuum pump mechanically removes air from the chamber and load through a single or multiple vacuum pulses of -0,75 Bargs. This process ensures steam can penetrate objects with complex geometries. Simultaneously, the steam generator is activated to inject steam into the sterilization chamber.

### HEATING PHASE

- After completing the prevacuum phase, the powerful integrated steam generator assembled outside the sterilization chamber heats up dramatically and injects saturated steam in the chamber.

### STERILIZATION PHASE

- Upon reaching the preprogrammed sterilization temperature inside the chamber, the sterilization phase begins, maintaining the temperature precisely for the programmed duration.
- This crucial step is controlled by a PT-100 Class A temperature probe located within the chamber. As an option for liquids sterilization processes, this phase can be regulated by a flexible PT-100 Class A temperature probe located inside a sample.

### VACUUM DRYING PHASE

- After the sterilization phase finishes, in solid programs only, a vacuum drying phase begins, using a vacuum pump and a heating jacket to completely dry the load.

### COOLING PHASE

- Finally, a natural cooling phase starts. A beep will sound upon reaching a safe temperature that allows the chamber to be opened.

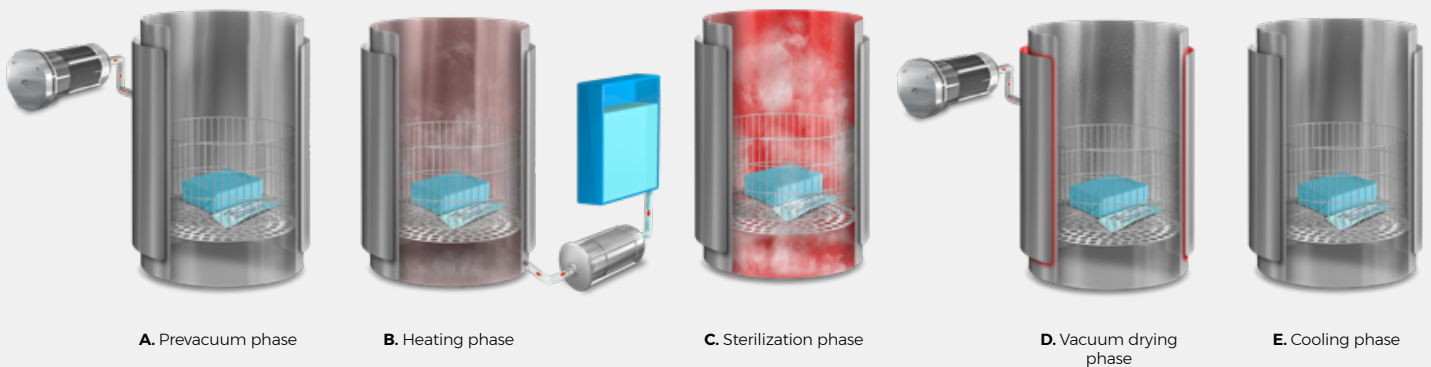
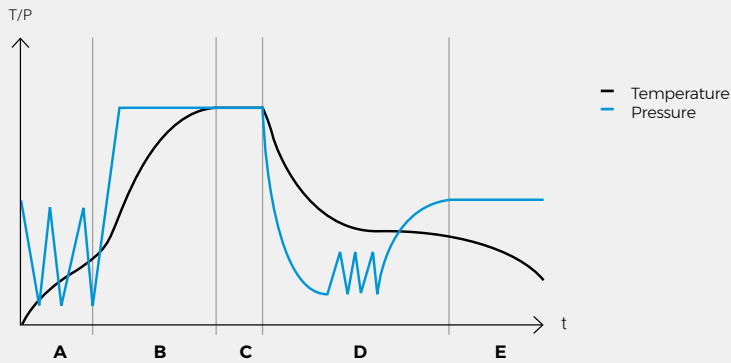

## PREDEFINED PROGRAMS

Program N°	Program name	Prevacuum pulses	Sterilization temperature °C	Sterilization time min	Drying time min	Program mode	Regulation by flexible probe
P1	BD	3	134	4'	4'	Solids	-
P2	Vacuum	1	-	-	-	Solids	-
P3	Porous-134	3	134	4'	15'	Solids	-
P4	Prion-134	3	134	18'	20'	Solids	-
P5	Poroso-121	3	121	20'	15'	Solids	-
P6	Hollow-134	3	134	4'	10'	Solids	-
P7	Hollow-121	3	121	20'	10'	Solids	-
P8	Wrapped-134	1	134	7'	20'	Solids	-
P9	Wrapped-121	1	121	20'	20'	Solids	-
P10	Solids-134	1	134	4'	10'	Solids	-
P11	Solids-121	1	121	20'	10'	Solids	-
P12	Flash-134	1	134	3'	1'	Solids	-
P13	Liquids	1	121	30'	-	Liquids	-
P14	Liquid probe	1	121	15'	-	Liquids	Yes

AE-B Series autoclaves have 50 programs, from P1 to P50, and the first fourteen are predefined and protected.

The remaining programs, P15 to P50, can be edited by setting the following parameters:

- Number of prevacuum pulses.
- Sterilization temperature.
- Sterilization time.
- Final drying time.
- Sterilization mode (Solids or Liquids).
- Temperature control of the sterilization cycle can be performed by the chamber temperature probe or by the combined use of the chamber probe and the flexible probe.

## DIGITAL MICROPROCESSOR WITH TOUCHSCREEN

Digital microprocessor with a 5" TFT - LCD touchscreen for an easy programming and parameters selection.

Sterilization parameters such as temperature and pressure, graphs, alerts and errors are displayed on the screen.



# AE-B Series

## LOADING CAPACITIES



### ISO ERLLENMEYER FLASKS

Autoclave model	Usable volume L	250mL (Ø85 x 143mm)				500mL (Ø105 x 183mm)				1000mL (Ø131 x 230mm)				2000mL (Ø166 x 280mm)			
		Total baskets	Units / basket	Total units		Total baskets	Units / basket	Total units		Total baskets	Units / basket	Total units		Total baskets	Units / basket	Total units	
				A	B			A	B			A	B			A	B
AE-50-B	50	3	7	21	28	1	4	4	12	1	1	1	3	1	1	1	2
AE-75-B	75	3	12	36	48	2	8	16	24	2	5	10	=	1	3	3	6
AE-110-B	110	4	12	48	60	3	8	24	32	3	5	15	=	1	3	3	9
AE-150-B	153	4	21	84	105	4	14	56	=	3	8	24	=	1	5	5	10

A: Number of units using standard baskets.

B: Number of units using specially designed baskets for the specific combination of autoclave model and container.



### ISO BOTTLES

Autoclave model	Usable volume L	250mL (Ø70 x 143mm)				500mL (Ø80 x 185mm)				1000mL (Ø101 x 230mm)				2000mL (Ø136 x 260mm)			
		Total baskets	Units / basket	Total units		Total baskets	Units / basket	Total units		Total baskets	Units / basket	Total units		Total baskets	Units / basket	Total units	
				A	B			A	B			A	B			A	B
AE-50-B	50	3	9	27	36	1	7	7	21	1	4	4	=	1	1	1	2
AE-75-B	75	3	20	60	80	2	14	28	42	2	8	16	=	1	4	4	8
AE-110-B	110	4	20	80	100	3	14	42	56	3	8	24	=	1	4	4	12
AE-150-B	153	4	33	132	165	4	24	96	=	3	15	45	=	1	8	8	24

A: Number of units using standard baskets.

B: Number of units using specially designed baskets for the specific combination of autoclave model and container.

The data contained within these tables, regarding load capacities, serves as a non-binding guide to assist you in the selection of the most appropriate autoclave model.

## ACCESSORIES

### INTEGRATED BASKET LIFT SYSTEM

References	CLASSIC-LIFT	CLASSIC-LIFT-R	
Dimensions L x D x H mm	800 x 300 x 2100	800 x 300 x 2600	
Power W	480	480	
Voltage V	230	230	
Frequency Hz	50/60	50/60	
Weight Kg	40	45	
Maximum load Kg	30	40	
For autoclaves with the following chamber volumes	79 L	✓	-
	115 L	✓	✓
	175 L	-	✓

- Stainless steel electric lift system built into the side of the autoclave with swivel arm to help load and unload heavy items. Push-button operation with opening up to 200°
- Motor with auto brake system in the event of obstacles or overload.
- Available in two models: the standard lift system and reinforced lift system.
- It can be factory fitted or retrofitted.



Download technical data sheet

### MOBILE BASKET LIFT SYSTEM

Reference	MOB-LIFT
Dimensions L x D x H mm	420 x 800 x 2200
Power W	200
Voltage V	115 - 230
Frequency Hz	50/60
Weight Kg	85
Maximum load Kg	30

- Stainless steel electric lift system with casters to help load and unload heavy items up to 30Kg.
- Equipped with long-life battery for cordless use.
- Push-button operation.
- Motor with auto brake system in the event of obstacles or overload.
- Compatible with any autoclave model.



Download technical data sheet

## ACCESSORIES

### STAINLESS STEEL WIRE BASKETS FOR STERILIZING CLEAN LOADS OR HEAVY ITEMS

References		CV-28	CV-75-130	CV-75S	CV-75	CV-150-130	CV-150S	CV-150M
Dimensions	External Ø x H mm	270 x 185	370 x 130	370 x 180	370 x 265	470 x 130	470 x 190	470 x 235
	Internal Ø x H mm	260 x 180	360 x 125	360 x 175	360 x 260	460 x 125	460 x 185	460 x 230
Maximum capacity for autoclaves with the following chamber volumes	33 L	2	-	-	-	-	-	-
	55 L	3	-	-	-	-	-	-
	79 L	-	4	3	2	-	-	-
	115 L	-	6	4	3	-	-	-
	175 L	-	-	-	-	6	4	3



### STAINLESS STEEL LIQUIDS COLLECTOR TRAY FOR WIRE BASKETS

References		TR-270	TR-370	TR-470
Dimensions	External Ø x H mm	240 x 50	320 x 50	420 x 50
	Internal Ø x H mm	238 x 48	318 x 48	418 x 48
For the following wire baskets models	CV-28	✓	-	-
	CV-75S & CV-75	-	✓	-
	CV-150S & CV-150M	-	-	✓



### UNPERFORATED STAINLESS STEEL BASKETS FOR STERILIZING DIRTY LOADS OR OBJECTS WITH RISK OF SPILLAGE

References		CCI-28	CCI-75S	CCI-75	CCI-150S	CCI-150M
Dimensions	External Ø x H mm	270 x 185	370 x 180	370 x 265	470 x 190	470 x 235
	Internal Ø x H mm	260 x 180	360 x 175	360 x 260	460 x 185	460 x 230
Maximum capacity for autoclaves with the following chamber volumes	33 L	2	-	-	-	-
	55 L	3	-	-	-	-
	79 L	-	3	2	-	-
	115 L	-	4	3	-	-
	175 L	-	-	-	4	3



### STAINLESS STEEL "SCHIMMELBUSCH" DRUM FOR STERILIZING INSTRUMENTS AND BIOHAZARDOUS LOADS

References		TBE-24x16	TBE-34x24	TBE-48x24
Dimensions	External Ø x H mm	240 x 165	340 x 240	480 x 240
	Internal Ø x H mm	230 x 155	330 x 230	470 x 230
Maximum capacity for autoclaves with the following chamber volumes	33 L	2	-	-
	55 L	4	-	-
	79 L	-	2	-
	115 L	-	3	-
	175 L	-	-	3



## ACCESSORIES

### STAINLESS STEEL CYLINDERS FOR STERILIZING PETRI DISHES

References		CEP-1027	CEP-1041	CEP-1427	CEP-1441
Dimensions	External Ø x H mm	100 x 270	100 x 410	140 x 270	140 x 410
Petri dishes	Maximum number dishes / cylinder	10	18	10	18
	Diameter Ø mm	80	80	120	120
Maximum capacity for autoclaves with the following chamber volumes	33 L	4	4	2	2
	55 L	8	4	4	2
	79 L	16	8	10	5
	115 L	24	16	15	10
	175 L	28	14	16	8



### STAINLESS STEEL CYLINDERS FOR STERILIZING PIPETTES

References		CEPP-726	CEPP-740	CEPP-1025	CEPP-1435
Dimensions	External Ø x H mm	70 x 260	70 x 400	100 x 250	140 x 350
	Internal Ø x H mm	60 x 250	60 x 390	90 x 240	130 x 340
Maximum capacity for autoclaves with the following chamber volumes	33 L	11	11	6	6
	55 L	22	11	12	12
	79 L	42	21	20	10
	115 L	63	42	30	20
	175 L	90	30	51	34

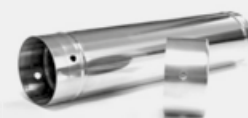

### STAINLESS STEEL WIRE BASKET WITH HEIGHT ADJUSTABLE TRAYS

References		SRA-R-300	SRA-R-400	SRA-R-500
External dimensions	Ø x H mm	250 x 190	350 x 180	450 x 180
Trays	References	TRAY-SRA-R-300	TRAY-SRA-R-400	TRAY-SRA-R-500
	Dimensions Ø x H mm	240 x 20	340 x 20	440 x 20
Maximum capacity for autoclaves with the following chamber volumes	33 L	2	-	-
	55 L	3	-	-
	79 L	-	3	-
	115 L	-	4	-
	175 L	-	-	4

\*The purchase of a tray support comes with a set of two trays and six fastening clips. Likewise, the purchase of a tray includes a set of three fastening clips.

- For sterilization of instruments, small bags and other small objects that must be placed straight up.
- Material: AISI-304 stainless steel.



## ACCESSORIES



### FLEXIBLE TEMPERATURE PROBE PT-100 CLASS A

After installing this accessory, the temperature regulation of the sterilization cycle can either be controlled by the main chamber temperature sensor or both the main chamber temperature sensor and the temperature sensor of the flexible temperature probe.

The temperature control by the flexible temperature probe is especially advantageous for processes involving the sterilization of large volumes of liquids, where the sterilization process is regulated by both the temperature achieved in the center of the liquid sample as well as the temperature achieved in the sterilization chamber. Furthermore, should the autoclave be opened at chamber temperatures higher than 80°C there is a risk of liquids boiling over which can be avoided if the temperature of the sample is controlled throughout the sterilization procedure.

Must be installed in our facilities.

**Ref. PT-2-B**

[Download technical data sheet](#)



### EXTERNAL DOT MATRIX PRINTER

Prints program number, cycle number, temperature, pressure, date and hour of the run and error messages.

Selectable print frequency between 10 and 240 seconds.

Connection: RS-232.

Requires a special factory adaptation.

**Ref. ITS**

**Consumables: PAPER-ITS for paper and 70945 for ribbon.**

[Download technical data sheet](#)



### EMBEDDED THERMAL PRINTER

Prints program number, cycle number, temperature, pressure, date and hour of the run and error messages.

Selectable print frequency between 10 and 240 seconds.

Must be installed at our factory.

**Ref. IT/TS**

**Consumable: PAPER-IT for paper**

[Download technical data sheet](#)

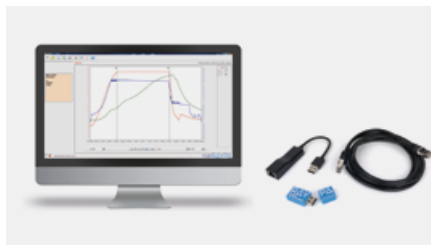

### SW8000 SOFTWARE

Communication software between the equipment and the PC for display and recording in real time or display after each cycle. Cycles can also be printed or exported to Excel.

PC connection via Ethernet. Data can also be exported directly to a USB memory stick.

**Ref. SW8000**

[Download technical data sheet](#)



### CABLE GLAND

Installation of a Ø2mm or Ø4mm cable gland to provide access to as many as eight external temperature probes for calibration and validation procedures.

**Ref. CG2MM & CG4MM**

[Download technical data sheet](#)

## ACCESSORIES



### EXTERNAL TEMPERATURE PROBE ADAPTER

External adapter for continuous validation processes that provides access to an external probe (Ø3-6mm) to take temperature readings that are independent of the equipment microprocessor.

It is located on the autoclave door.

Must be installed at our factory.

**Ref. EXT-TP**



[Download technical data sheet](#)



### TRANSPORT TROLLEY

Auxiliary trolley to aid in the loading and unloading of the autoclave.

Made of chrome iron and plastic.

The surface of each shelf is textured to prevent the load from moving.

Equipped with rubber casters to reduce noise and prevent floor wear.

Dimensions (LxDxH): 730x490x700mm

**Ref. TR-TR**



[Download technical data sheet](#)



### AUTOMATIC WATER FILLING

Water pump for automating the supply of purified water to the tank.

Compatible with installations with a purified water network or a purified water tank, or installations with a non-purified water network; in the latter case, a water purifier (ECOPUR-500) and a purified water tank (TANK-KLL) will be required.

Must be installed at our factory.

**Ref. KLL-B**



[Download technical data sheet](#)



### ECO-EFFICIENT WATER PURIFIER

Eco-efficient direct-flow water purifier with LED display and no accumulation of water. Capable of filtering 1,3L/min.

The installation of this accessory requires the joint installation of the external tank (TANK-KLL) and the automatic water filling system (KLL-B).

**Ref. ECOPUR-500**



[Download technical data sheet](#)



### PURIFIED WATER TANK

Alternative solution for the storage of up to 25L of purified water in the absence of a water network.

**Ref. TANK-KLL**



[Download technical data sheet](#)



### DISCHARGE TANK

Discharge tank with a maximum capacity of 25L to collect autoclave drain water during the purge and cooling phases in the absence of a drain.

**Ref. TANK-B**



[Download technical data sheet](#)

# AE-B Series

## ACCESSORIES



### TEMPERATURE DATA LOGGER

AISI-316L stainless steel disk temperature recorder with connection base and software.

Recommended for autoclave validation and for monitoring the internal temperature of containers.

Available in different sizes.

**Ref. BDL-DISK3618\_CL**



[Download technical data sheet](#)



### STERILIZATION CONTROL TAPE

Class 1 indicator for steam sterilization. The color change indicates that the materials have been processed; however, this does not guarantee adequate sterilization. Additional methods, such as biological indicators (EN ISO 11138), are required.

Pack of 5 rolls of 50m x 19mm tape.

**Ref. TEST-CT**



[Download technical data sheet](#)



### PACK OF BOWIE & DICK TESTS

Class B indicator printed with non-toxic inks and laminated to verify the complete steam penetration in porous loads.

Box with 20 tests.

**Ref. TEST-BD**



[Download technical data sheet](#)



### INTERNAL RADIAL FAN

Optimize and reduce cooling time, ensuring greater efficiency in sterilization processes.

Must be installed in our facilities.

**Ref. AIRCOOL-V**



[Download technical data sheet](#)



### HEAT EXCHANGER

Keeps wastewater below 60°C, preventing damage to pipes and components not suitable for temperatures above 80°C.

**Ref. HX-TEMP-2**



[Download technical data sheet](#)

## SPECIFIC SERVICES



### IQ-OQ DOCUMENTATION

Delivery of documentation and protocols for autoclave qualification through a third party.

**Ref. IQ-OQ DOC**



[Download technical data sheet](#)



### IQ-OQ-PQ QUALIFICATION

Autoclave qualification service performed by RAYPA technicians or authorized entities. It covers the startup of the equipment and the comprehensive qualification of its performance.

**Ref. IQ-OQ-PQ**



[Download technical data sheet](#)



### CALIBRATION CERTIFICATE FOLLOWING ENAC TRACEABILITY STANDARDS

Unitary certification of proper equipment calibration and performance in compliance with international standards.

**Ref. MAPEO-ENAC**



### MAPPING OF STABILITY AND HOMOGENEITY

Generation of documentary evidence certifying that the temperature and pressure distribution within the autoclave is uniform and stable, in accordance with the manufacturer's design specifications.

**Ref. MAP-3, MAP-7 and MAP-9**



### ON-SITE COMMISSIONING & TRAINING

On-site commissioning, which includes verification of the correct operation and installation of the equipment and a training session for users on the use and maintenance of the equipment.

**Ref. INSTAEB**



[Download technical data sheet](#)



### REMOTE COMMISSIONING & TRAINING

Guided remote startup including a training session for users on the operation and maintenance of the equipment.

**Ref. INSTAEB-REM**



[Download technical data sheet](#)



### MAINTENANCE CONTRACT

Regular inspection plan that includes technical inspection, probe calibration and compliance with the preventive maintenance plan, in addition to tariff discounts.

**Ref. MANT-1.2 and MANT-1.3**



### EXTENDED WARRANTY

Extended warranty up to a total of 3 years.

**Ref. WE-CL**

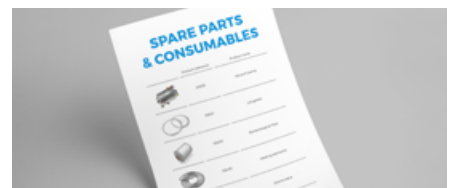

### SET OF CONSUMABLES, SPARE PARTS AND ESSENTIAL COMPONENTS

Set of original spare parts, consumables and components, chosen specifically to adhere to each model's maintenance plan, intended to maximize equipment longevity and minimize downtime in the event of a malfunction.

## TECHNICAL DRAWINGS OF THE AUTOCLAVE

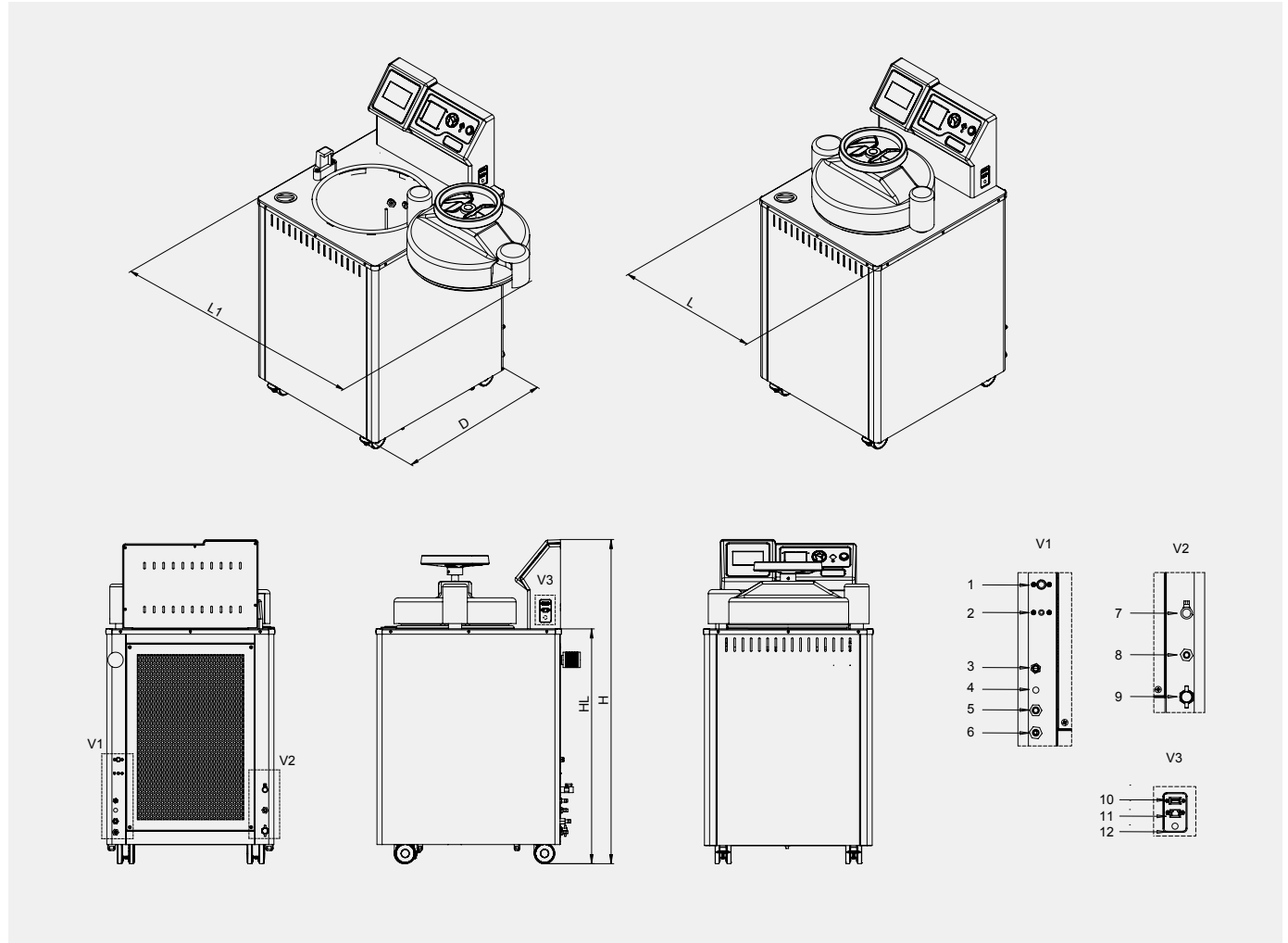

MODELS	L LENGTH with closed door	L1 LENGTH with maximum door opening	D DEPTH	H HEIGHT	HL LOAD HEIGHT	HD DIRECT DISCHARGE CONNECTION HEIGHT
AE-50-B	505 mm	900 mm	580 mm	1290 mm	939 mm	125 mm
AE-75-B	610 mm	1100 mm	700 mm	1185 mm	834 mm	125 mm
AE-110-B	610 mm	1100 mm	700 mm	1435 mm	1084 mm	125 mm
AE-150-B	750 mm	1380 mm	820 mm	1400 mm	1043 mm	125 mm

### CONNECTIONS

1	Heating jacket safety thermostat	7	Independent clean water tank drain outlet
2	Steam generator safety thermostat	8	Independent clean water tank overflow outlet
3	Power supply cable (AE-110-B and AE-150-B models)	9	Access to the drain filter of the sterilization chamber
4	Safety valve outlet	10	USB Port
5	Automatic water supply inlet	11	Ethernet Port
6	Direct discharge outlet	12	Power supply cable (AE-50-B and AE-75-B models)

## TECHNICAL DRAWINGS OF THE AUTOCLAVE + CLASSIC-LIFT

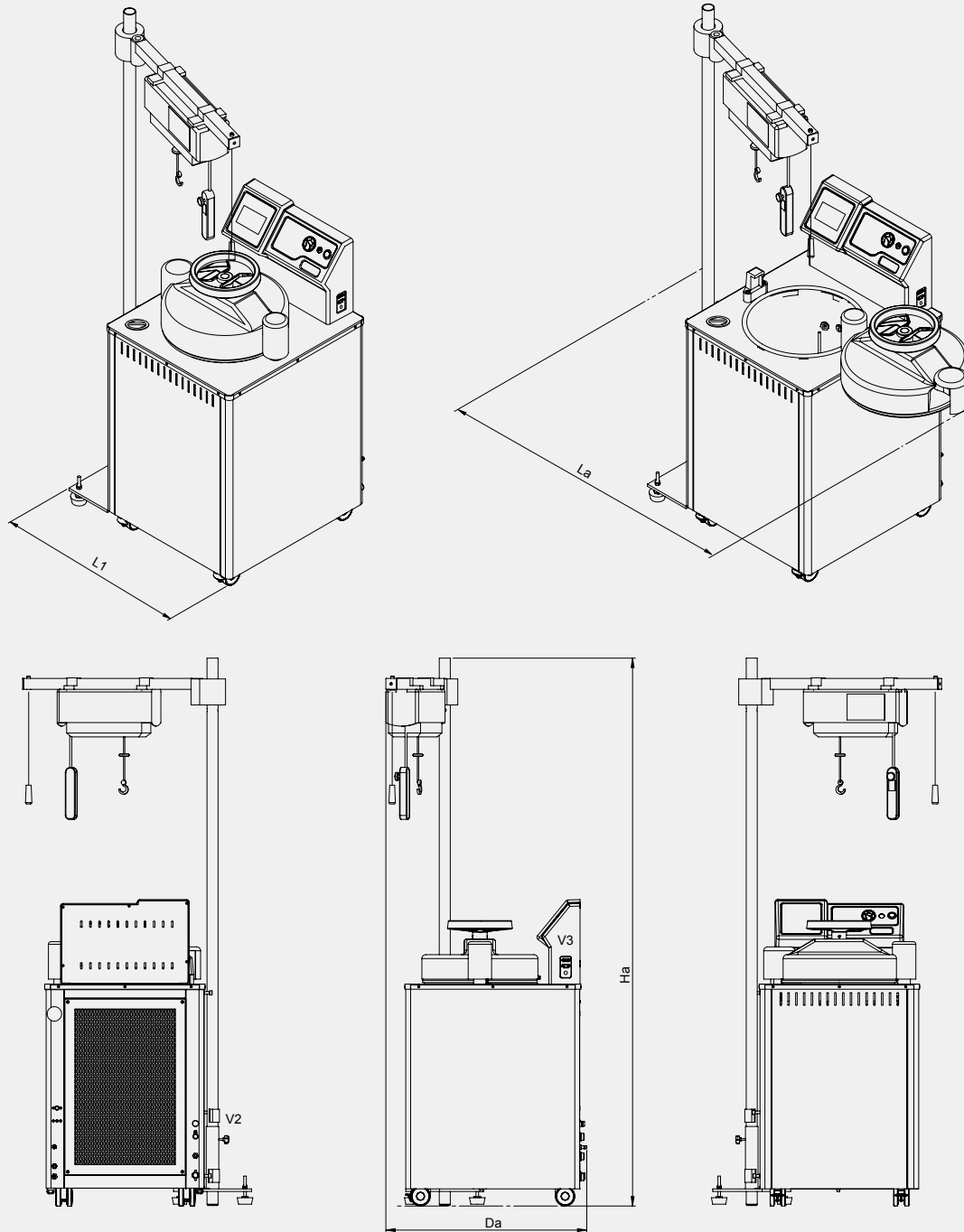

### MODEL OF BASKET LIFT SYSTEM

### DIMENSIONS OF BASKET LIFT SYSTEM L x D x H

### AUTOCLAVE MODELS

### DIMENSIONS OF BASKET LIFT SYSTEM + AUTOCLAVE La x Da x Ha

CLASSIC-LIFT

800 x 300 x 2100 mm

AE-75-B

1276 x 1296 x 2100 mm

AE-110-B

CLASSIC-LIFT-R

800 x 300 x 2600 mm







AE-110-B

1276 x 1296 x 2600 mm

AE-150-B

1543 x 1536 x 2600 mm

## TECHNICAL SUMMARY

 General classification	Recommended setting	Industry and research laboratories
	Equipment placement	Floor-standing
	Load direction	Top-loading
	Chamber profile	Round
 Recommended type of load	Porous solids and wrapped loads	++
	Objects with complex geometries	++
	Plastic and metal objects	++
	Glassware	
	Laboratory waste bags	
	Culture media and liquids	++
 Sterilization technology	Method to generate steam	Integrated steam generator
	Type of purge	Vacuum
	Prevacuum pulses by vacuum pump	✓
	Vacuum drying by heating jacket and vacuum pump	✓
 Transfer of data	Ethernet & USB	✓
 Batch printers	Integrated printer	0
 Sterilization chamber and door specifications	Sterilization chamber volume	55 - 175 L
	External building material	AISI-304
	Sterilization chamber material	AISI-316L
	Vacuum pump	Membrane
	Gasket material	Silicone rubber
	Min. - max. sterilization temperature	105 - 134 °C
	Maximum pressure (above atmospheric pressure)	2,1 Barg
	Mechanism to open the door	Manual wheel
	Direction in which the door opens	Lateral
	Automatic locking with pressure	✓
	Thermally insulated door	✓
 User interface and microprocessor	Screen display	TFT touchscreen
	Screen size	5"
	Total number of available programs	50
	User management with administrator hierarchy	✓
	Automatic microprocessor control	✓
 Special cycles and process optimization	Timer start	✓
	Auto-preheating	✓
	Vacuum leak test	✓
	Bowie Dick test	✓
	Final postvacuum drying (to completely dry solid loads)	✓
	Temperature regulation by flexible probe	0
 Adjustable cycle parameters	Number of prevacuum pulses	1 - 3
	Temperature of sterilization phase	105 - 134 °C
	Duration of sterilization phase	1 - 250 min
	Duration of drying phase	1 - 360 min
	Temperature regulation by flexible probe	On/Off
	Sterilization mode (solids or liquids)	✓
 Other specifications	Air intake with bacteriological filter	✓
	Independent clean water tank capacity	9 - 20 L
	Flexible probe	0
	Premium casters with brakes	✓
	Pressure gauge	✓
 Services	Electric customization (115-230M V/230-400T V)	0
	Third-party qualification (IQ-OQ-PQ)	0

++ Recommended ✓ Standard 0 Optional

## TECHNICAL DATA

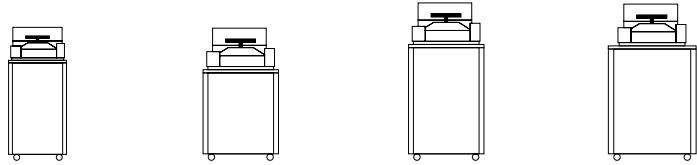

### Specifications

References	AE-50-B	AE-75-B	AE-110-B	AE-150-B
Usable dimensions of the chamber L	55/50	79/75	115/110	175/153
Usable dimensions of the chamber Ø x H mm	300 x 710	400 x 600	400 x 850	500 x 780
External dimensions L x D x H mm	505 x 580 x 1290	610 x 700 x 1185	610 x 700 x 1435	750 x 820 x 1400
Loading height mm	975	870	1120	1085
Net weight Kg	99	135	165	245
Available heating capacities W	3600	3600 or 6000	6000 or 9000	6000 or 9000
Standard voltage* V	230	230	400	400
Frequency Hz	50/60	50/60	50/60	50/60

\*Other voltages and electrical configurations available on request. Special models with increased power may operate with other voltages.

### Safety features

- Safety valve.
- Safety thermostats with manual rearm for the heating jacket and the steam generator.
- Pneumatic door blocking system while positive pressure exists inside the sterilization chamber.
- Open door sensor.
- Thermally insulated door.
- Water level detector in the integrated steam generator.
- Water level detector (min./max.) in the independent clean water tank.
- Bacteriological filter for inlet air.
- Several visual and acoustic safety and warning alarms.

### Regulations

All our AE-B Series autoclaves are designed to comply with the strictest international directives and standards, including the following regulations:

- **EN-61010-1** Safety requirements for electrical equipment for measurement, control and laboratory use. **Part 1:** General requirements.
- **EN-61010-2-040 Part 2-040:** Requirements for laboratory autoclaves.
- **EN-61326** Electrical equipment for measurement, control and laboratory use. EMC requirements.
- **AD 2000 Merkblatt** Pressure vessels
- **2014/35/UE** Low voltage.
- **2014/30/UE** Electromagnetic compatibility.
- **2014/68/UE** Pressure equipment.

### General features

Adjustable sterilization temperature	105 - 134 °C
Adjustable sterilization time	1 - 250 min
Adjustable prevacuum pulses	1 - 3
Adjustable drying time	1 - 360 min
Maximum pressure	2,1 Bar
Sterilization control system	Fully automatic microprocessor control using either a chamber temperature probe or flexible temperature probe
Air purge system	Mechanical displacement by vacuum pump
Heating system	Independent integrated steam generator
Vacuum drying system	Vacuum pump plus heating jacket
Prevacuum system	Vacuum pump
External building material	AISI-314 stainless steel
Sterilization chamber material	AISI-316L stainless steel
Gasket material	Silicone rubber
Connection to PC	Ethernet
Connection to printer	Embedded
Number of programs	50 (14 preset and 36 user free)
Programmable auto-start	Unlimited range
Screen type	5" TFT touchscreen
Opening door mode	Horizontal swiveling door with blocking wheel
Monitoring of sterilization parameters	Self-control of obtained values (T°, P & t) vs programmed values. Cycle is automatically interrupted if obtained values differ from programmed values
Pressure display	Pressure gauge on control panel, digital display on screen, registry on software and printed tickets
Water management	Independent manually fed clean water tank that automatically supplies the independent integrated steam generator. Optional upgrade for full automation of water supply directly from a water network
Drainage system	Drainage connections for the direct discharge, to drain the independent clean water tank and for the overflow of the independent clean water tank
Castors	Medical grade casters with brakes

## MORE INFORMATION

 Watch video

 Download the installation guide



# RAYPA

[www.raypa.com](http://www.raypa.com)

Avinguda del Vallès, 322  
08227 Terrassa (Barcelona) Spain

